

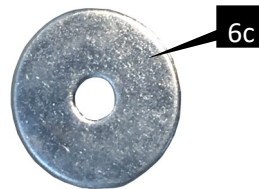

# Whole House Fan

WHF 1500VS, GF 1500T, WHF 3000VS, GF 3000T  
Installation Instructions

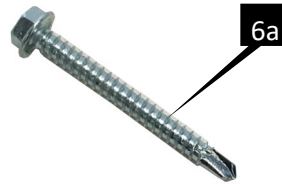
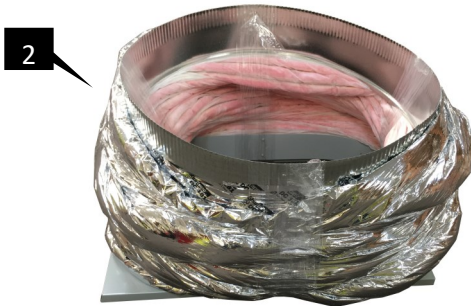

Parts List *		Quantity
1	Fan Assembly (WHF 3000VS Shown)	(1)
2	Damper Box Cover and Insulated Ducting Assembly	(1)
3	Damper Box	(1)
4	Fan Grill	(1)
5	HushMount™ Assembly	(1)
	Fastener Kit	
6	a. Screw #8 X 1-1/2 (38 mm) Hex Head Drill Tip	(12)
	b. Screw #8 X 5/8 in (16 mm) Hex Head Drill Tip	(14)
	c. Washer	(2)
7	Variable Speed Remote Control (Sold Separately)	
8	Nylon Strapping (Sold Separately) (Not Shown)	
9	Foil Tape (Sold Separately) (Not Shown)	

## Required Tools:

Keyhole Saw

Screw Gun with 1/4 in Nut Driver (Hex Head)

Tape Measure

Utility Knife

Screwdriver with Phillips Head

Pencil

Required Safety Equipment



# Whole House Fan

## WHF 4500VS, WHF 6000VS

### Installation Instructions



Parts List *		Quantity
1	Fan Assembly (WHF 6000VS Shown)	(2)
2	Damper Box Cover and Insulated Ducting Assembly	(2)
3	Damper Box	(2)
4	Fan Grill	(1)
5	HushMount™ Assembly	(2)
6	Fastener Kit	
	a. Screw #8 X 1-1/2 in (38 mm) Hex Head Drill Tip	(24)
	b. Screw #8 X 5/8 in (16 mm) Hex Head Drill Tip	(28)
	c. Washer	(4)
7	Variable Speed Remote Control (Sold Separately)	
8	Nylon Strapping (Sold Separately) (Not Shown)	
9	Foil Tape (Sold Separately) (Not Shown)	

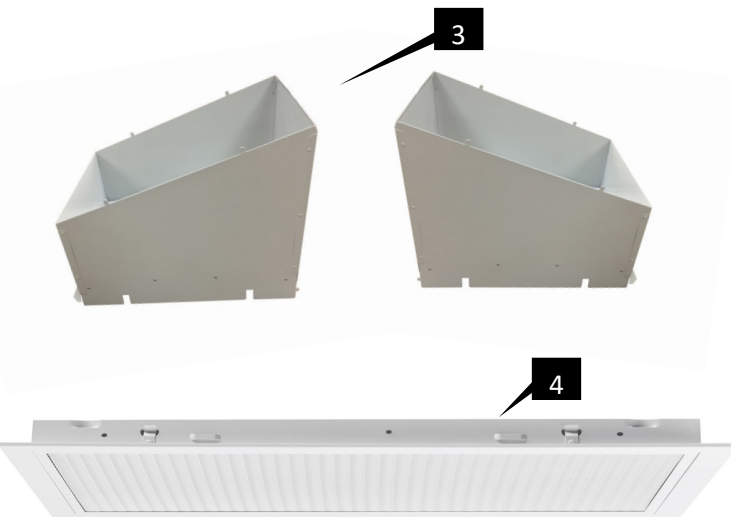

#### Required Tools:

Keyhole Saw
Screw Gun with 1/4 in Nut Driver (Hex Head)
Tape Measure
Utility Knife
Screwdriver with Phillips Head
Pencil
Required Safety Equipment

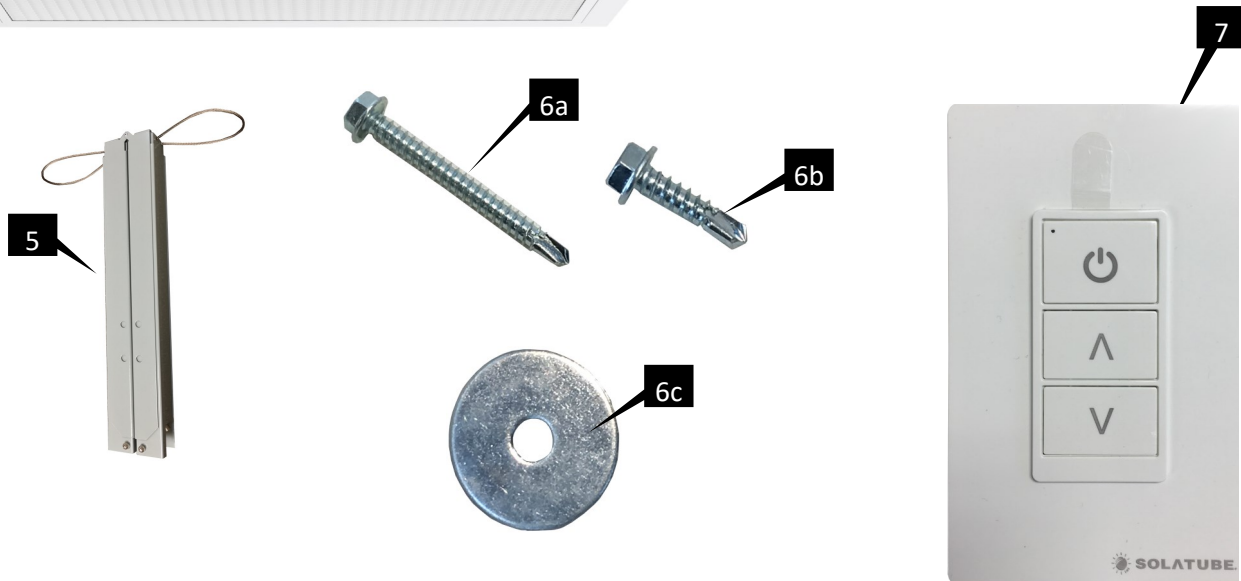

For the most current Installation Instructions, please visit [www.solatube.com/instructions](http://www.solatube.com/instructions)

# **WARNING**



**Do not proceed with the installation until you have read the entire instructions, including these warnings. Use of materials or methods not authorized by Solatube International will result in an invalid warranty.**

Solatube International, Inc. (seller) assumes no responsibility or obligation whatsoever for the failure of an architect, contractor, installer, or building owner to comply with all applicable laws, ordinances, building codes, electrical codes, energy codes, fire and safety codes and requirements, roof warranties and adequate safety precautions. Installation of this product should be attempted only by individuals skilled in the use of the tools and equipment necessary for installation. Protect yourself and all persons and property during installation. If you have any doubt concerning your competence or expertise, consult a qualified expert before proceeding. **Deviation from these instructions in any manner, including application and mounting, will result in a voided warranty.**

## **Install at your own risk!**



Solatube product installations may be dangerous and include the potential for death, personal injury and property damage. The hazardous conditions include but are not limited to the following:

- Solatube Daylighting Systems, Solar Star products, and Whole House Fan ventilation systems may have sharp edges. Always wear leather or canvas gloves while handling and installing products.
- Solatube product installations require climbing and working at dangerous heights, including on ladders, scaffolding, roofs and in attic spaces. Risk of death, personal injury and property damage may result from a fall, or from falling objects. Use extreme caution to minimize risk of accidental injury, including, but not limited to the following procedures:
  - Clear area below your work space of all people, animals and other items.
  - Avoid working on surfaces that are slippery or wet.
  - Use foot-wear with excellent traction.
  - Use only strong, well supported ladders.
  - Work only in calm dry weather.
  - When in the attic, ensure that your weight is supported at all times with structurally sound framing; drywall material is not designed to carry a person's weight.
- To reduce the risk of fire, electric shock, and personal injury, basic safety precautions should always be followed when using electric tools, including always wearing safety goggles or other suitable eye protection, and ensuring work area is clear of all electrical wires, gas pipes, water pipes, and other obstacles.
- When working in the attic or other dusty areas, use of a mask or respirator is recommended to avoid lung irritation. Attic spaces may be dark, confined, and subject to extreme temperatures. Beware of sharp protruding objects. Do not attempt installation without having someone within range of your voice or close enough to come to your aid if necessary.
- Solatube products are not designed to withstand the weight of a person, tools or other objects. Walking or placing objects on the system could cause personal injury and property damage. If the product is damaged, the structural capacity may be weakened; therefore the system should be repaired immediately. For safe installation and use, do not deviate from these installation instructions.



## **Whole House Fan Installation Tips**

These instructions are a step-by-step guide for the installation of Solatube Whole House Fan ventilation products in the following conditions.

**PLEASE READ AND SAVE THESE INSTRUCTIONS**

## **WARNING**

**To Reduce The Risk Of Fire Or Electric Shock, Do Not Use This Fan With Any Solid-State Speed Control Device. Electrical Connections Should Only be Performed By A Licensed Electrician.**

## **To Reduce The Risk Of Fire, Electric Shock, Or Injury To Persons, Observe The Following:**

- Use this unit only in the manner intended by the manufacturer. If you have questions, please contact your Solatube International representative.
- Before servicing or cleaning unit, switch power off at service panel and lock the service disconnecting means to prevent power from being switched on accidentally. When the service disconnecting means cannot be locked, securely fasten a prominent warning device, such as a tag, to the service panel.

## **Caution**

- For General Ventilation Use Only. Do Not Use To Exhaust Hazardous or Explosive Materials and Vapors.
- Installation work and electrical wiring must be done by qualified persons (s) in accordance with all applicable codes and standards, including fire rated construction.
- Sufficient air is needed for proper combustion and exhausting of gases through the flue (chimney) of fuel burning equipment to prevent back drafting. Follow the heating equipment manufacturer's guidelines and safety standards such as those published by the National Fire Protections Association (NFPA), and the American Society for Heating, Refrigeration and Air Conditioning Engineers (ASHRAE), and local code authorities.
- When cutting or drilling into wall or ceiling, do not damage electrical wiring and other hidden utilities.
- If this unit is to be installed over a tub or shower, it must be marked as appropriate for the application and be connected to a GFCI (Ground Fault Circuit Interrupter) - Protection branch circuit.

For the most current Installation Instructions, please visit [www.solatube.com/instructions](http://www.solatube.com/instructions)

Solatube International, Inc. | 2210 Oak Ridge Way | Vista, CA 92081-8341 | [www.solatube.com](http://www.solatube.com) | T: 888.SOLATUBE

## Overview

### Locate Desired Placement of the Whole House Fan

**NOTE:** The attic must be large enough to accommodate the Whole House Fan in the chosen location. There must be a minimum vertical clearance of 30" from top of ceiling joist to roof rafter. Also, the attic must have accessible power close enough to be able to plug in the fan or hard wire to existing electrical.

**NOTE:** Please ensure that there is adequate net free ventilation for the Solatube Whole House Fan. You will need one (1) square foot of net free vent area for every 750 CFM of fan capacity.

## WARNING

Avoid backdrafting of combustion appliances (i.e. gas fired water heaters and gas fired furnaces) by ensuring adequate ventilation is available and properly maintained. It is recommended to test the ventilation system to ensure intake and outlet ventilation is properly balanced. In some cases, it may be necessary to increase the number of vents to achieve this. *When installing ventilation systems into a garage, it is recommended to test the system to ensure backdrafting is not occurring regardless of the amount of venting.*

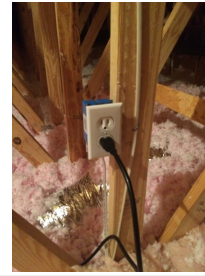

1

### Mark Ceiling Locations for Damper Box Between Joists

In the attic, use a keyhole saw to make two holes in the drywall against the edge of the joist. This will work as a guide for the template used in the next step. Ensure that one of the holes is used as the corner alignment and ensure the grill will be in the desired location on the ceiling.

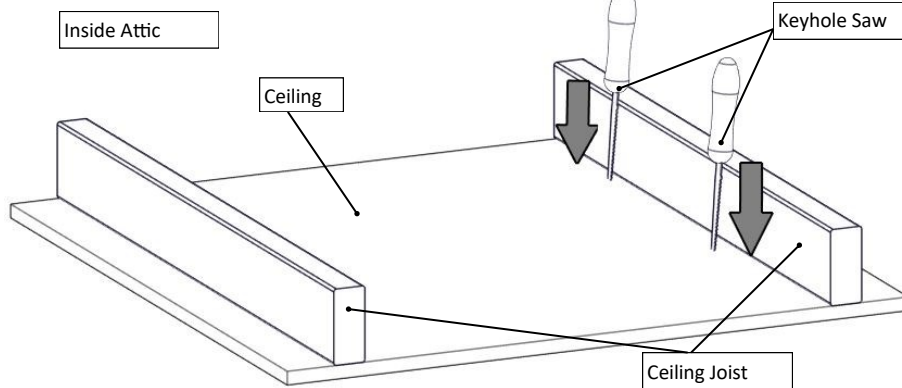

2

### Create a Template

Place the Damper Box on the cardboard box and trace the outside edge onto the box. Next cut the template using a razor knife.

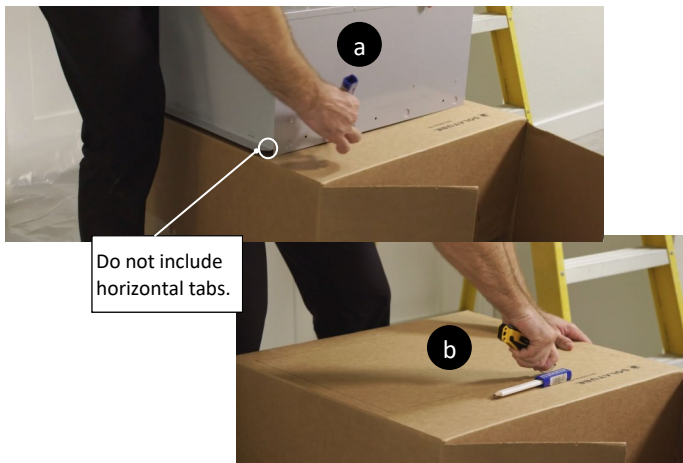

3

### Trace Template onto Ceiling

Align the corner edge of template with one hole and the side with the second hole to ensure the opening will be aligned with the joist. Next trace the template to the Ceiling.

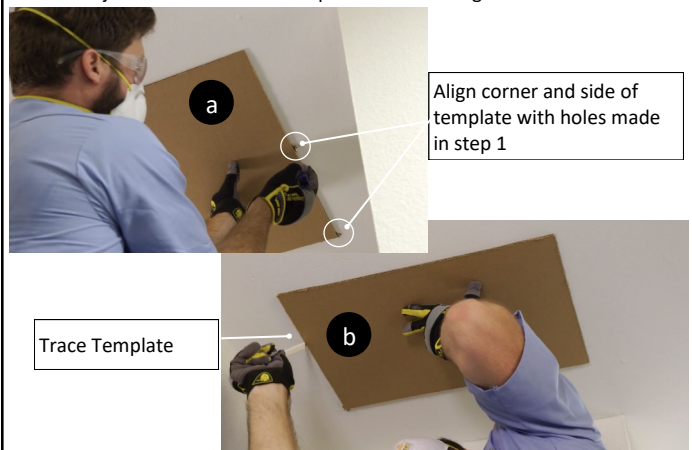

4

For the most current Installation Instructions, please visit [www.solatube.com/instructions](http://www.solatube.com/instructions)

Solatube International, Inc. | 2210 Oak Ridge Way | Vista, CA 92081-8341 | [www.solatube.com](http://www.solatube.com) | T: 888.SOLATUBE

4

Cut Ceiling Hole  
Score traced line with a razor knife then use a keyhole saw to cut along traced line

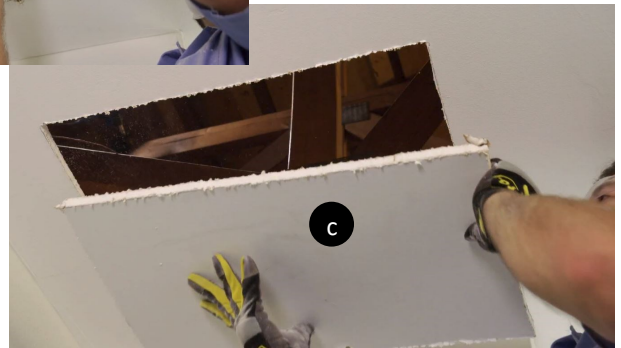
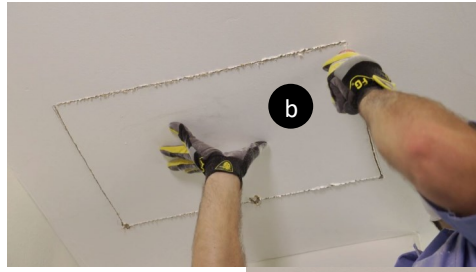
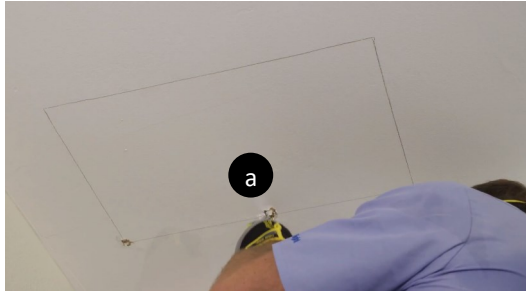

5

Insert Materials into Attic  
Place all remaining materials into the attic through the cut opening. Then insert Damper Box

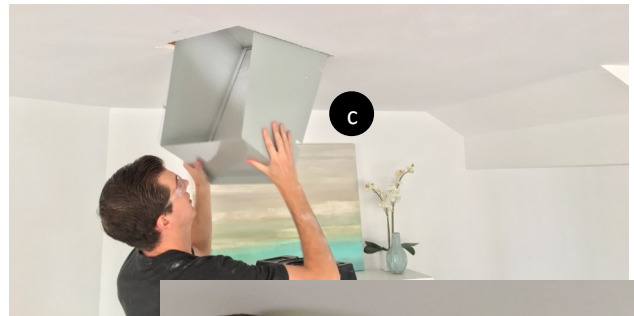
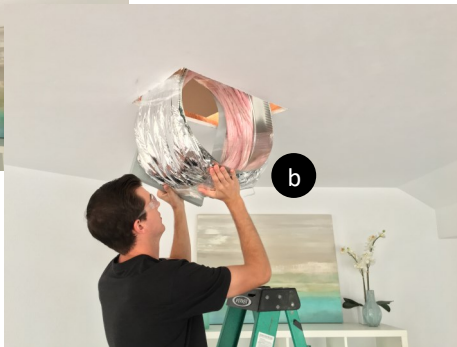
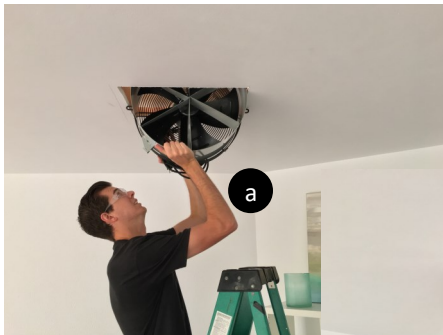

### Alternate Instructions for GF 1500T/GF 3000T



Caution: When installing the GF 1500T /GF 3000T (Garage Installation Only) ensure the fire damper doors are open and the fusible link is engaged for proper operation of the fire dampers. Fire Dampers are required for all garage applications.

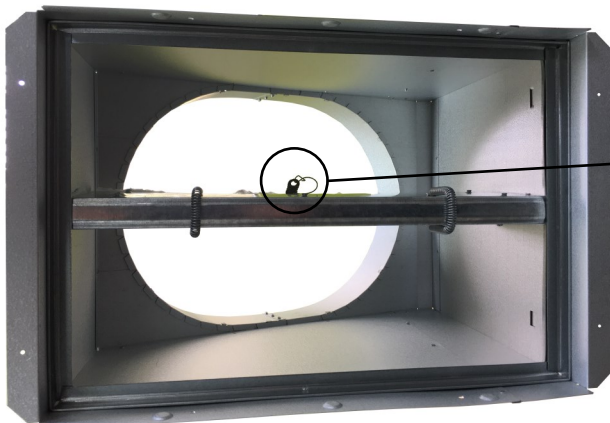

For the most current Installation Instructions, please visit [www.solatube.com/instructions](http://www.solatube.com/instructions)  
Solatube International, Inc. | 2210 Oak Ridge Way | Vista, CA 92081-8341 | [www.solatube.com](http://www.solatube.com) | T: 888.SOLATUBE

**Alternate Instructions for WHF 4500VS and WHF 6000VS Assemble Damper Boxes**

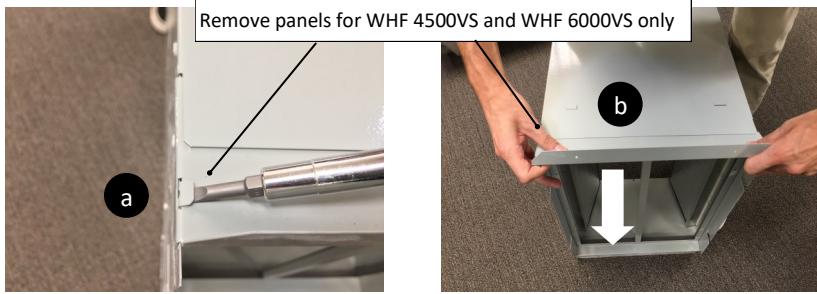

Remove panels for WHF 4500VS and WHF 6000VS only

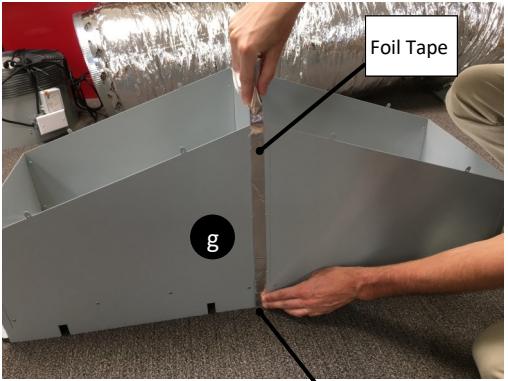

Foil Tape

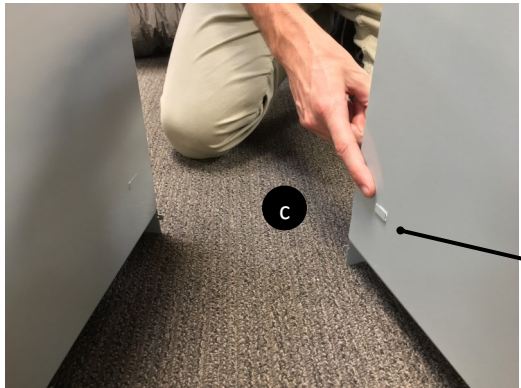

c

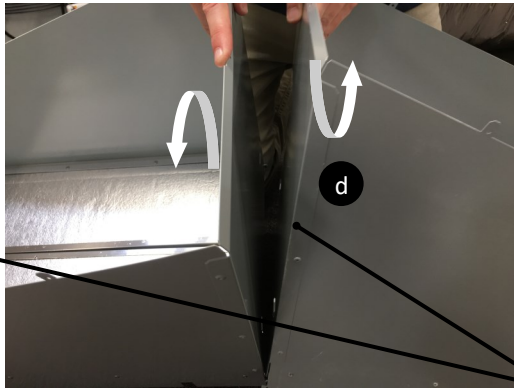

d

Tape Connected Damper Boxes

Connect Damper Boxes with tabs on back wall of each Damper Box. Carefully hook each tab to secure

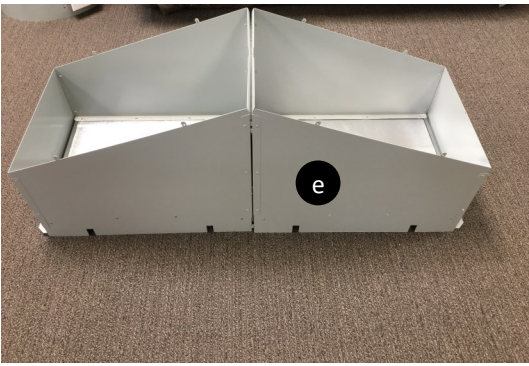

e



f

Secure Damper Boxes together with one (1) 5/8 in. Hex Head screw

Ensure screw is placed high in the Damper Box to allow the damper doors to open properly

**Alternate Continued**

**Create a Template**  
Place the Damper Boxes on the cardboard box and trace the outside edge onto the box. Next cut the template using a razor knife.

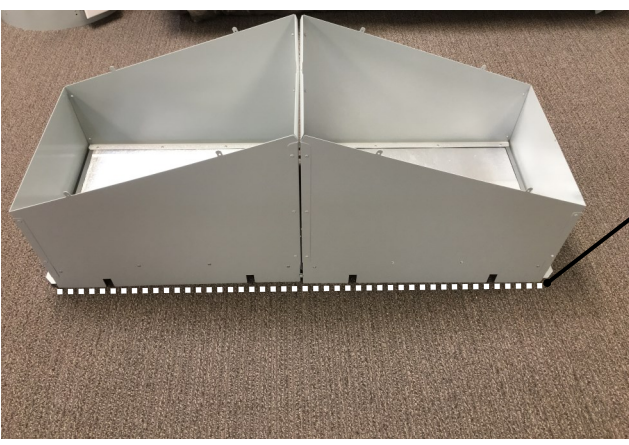

Trace outside edge of Damper Box and cut with razor knife

Trace Template onto Ceiling  
Follow the same process as step 3 to trace larger opening



## Alternate Instructions for WHF 4500 VS and WHF 6000VS

### Insert Damper Boxes into Ceiling

Ensure all sides of the damper boxes are centered on the hole and one side of the damper box is snug against the joist

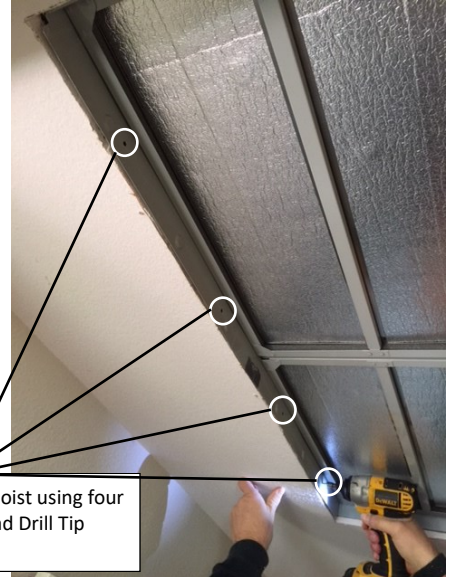

Secure the Damper Box to the joist using four evenly spaced 1-1/2 in Hex Head Drill Tip screws

6

### Fasten Damper Box to Joist

Secure the Damper Box to the joist using three evenly spaced 1-1/2 in Hex Head Drill Tip screws

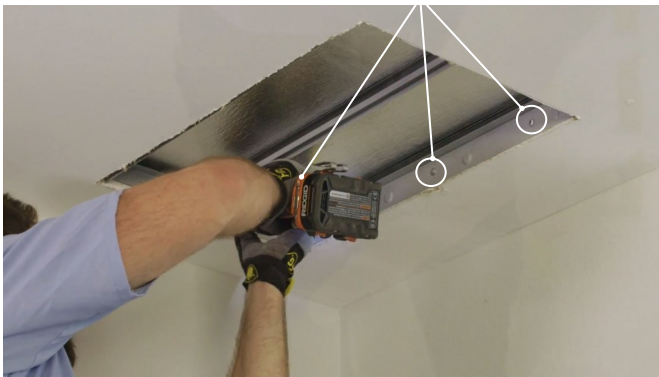

7

### Insert Grill Frame

Slide Grill Frame into Damper Box



7a

### Insert Grill Frame for WHF 4500VS or WHF 6000VS

Slide Grill Frame into Damper Box



8

### Fasten Grill Frame to Damper Box for WHF 1500VS and WHF 3000VS

Press Grill Frame against the ceiling. While firmly grasping the Damper Box and Grill Frame together, fasten to Damper box using two (2) 5/8 in Hex Head Drill Tip screws on each side of Grill Frame (four (4) total)



⚠ Ensure Damper Box and frame are pulled tightly together to prevent vibration.

8a

Fasten Grill Frame to Damper Box for WHF 4500VS and WHF 6000VS

Press Grill Frame against the ceiling. While firmly grasping the Damper Box and Grill Frame together, fasten to Damper box using four (4) 5/8 in Hex Head Drill Tip screws on each side of Grille Frame (eight (8) total).

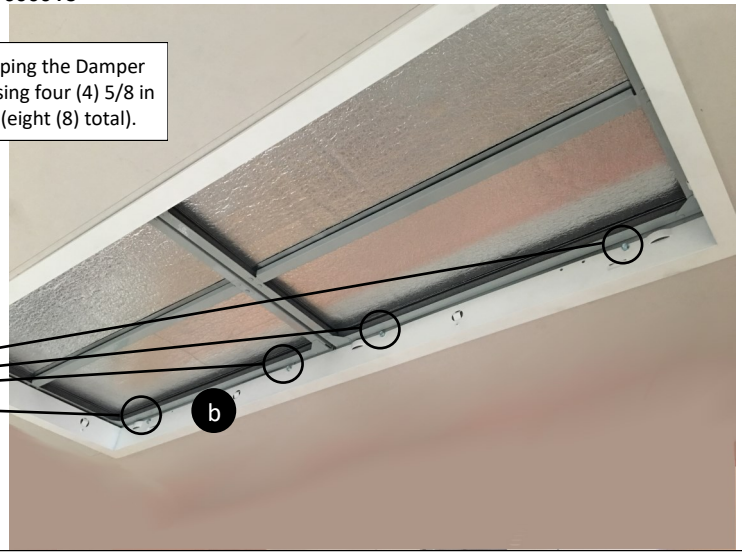
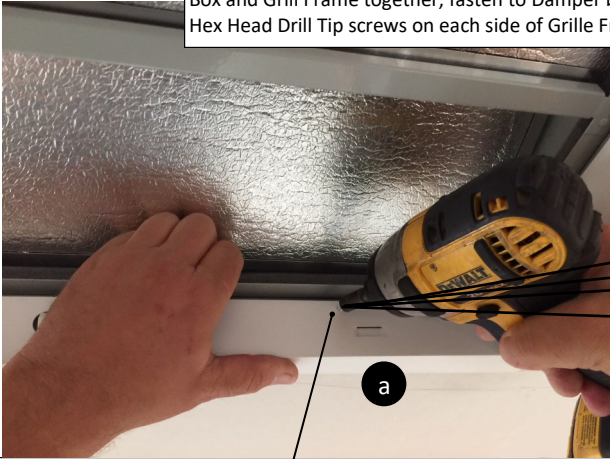

**NOTE:** Install screws high enough on Grill Frame to ensure they will not interfere with the Fan Grill installation.

9

Install Intake Grate

Slide Intake Grate into frame and snap into place.

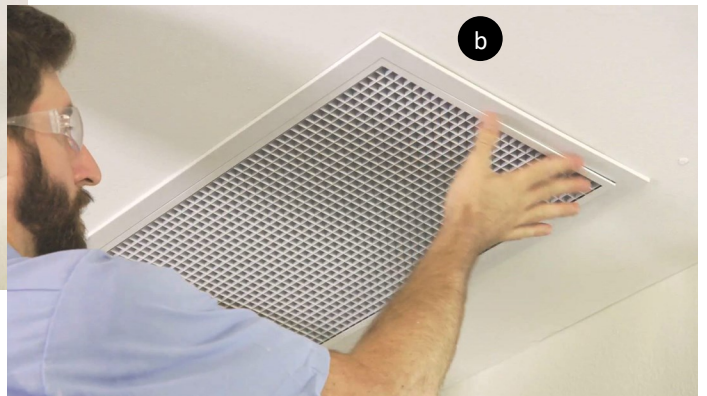

The remaining steps are performed in the attic.

10

Place Ducting and Box Cover onto Damper Box

Cut plastic packaging



Place beveled end of cover into lower end of Damper Box



For the most current Installation Instructions, please visit [www.solatube.com/instructions](http://www.solatube.com/instructions)



# 11

## Attach cover to Damper Box

Push cover onto Damper Box while slightly pressing the sides of the Damper Box inwards

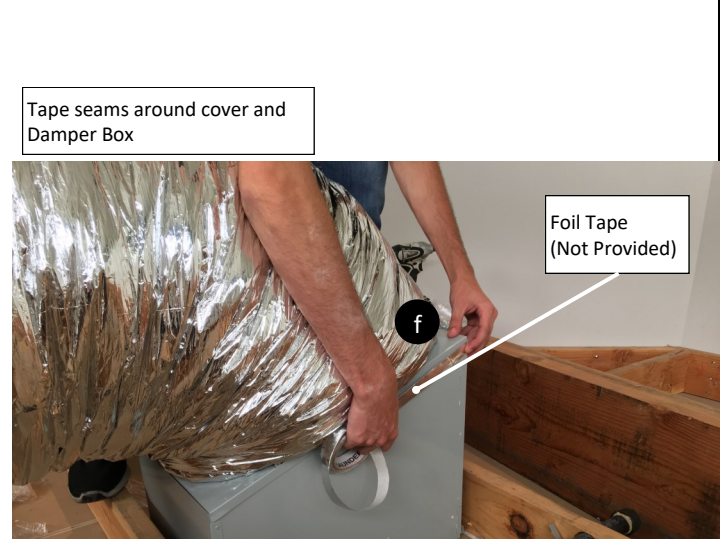
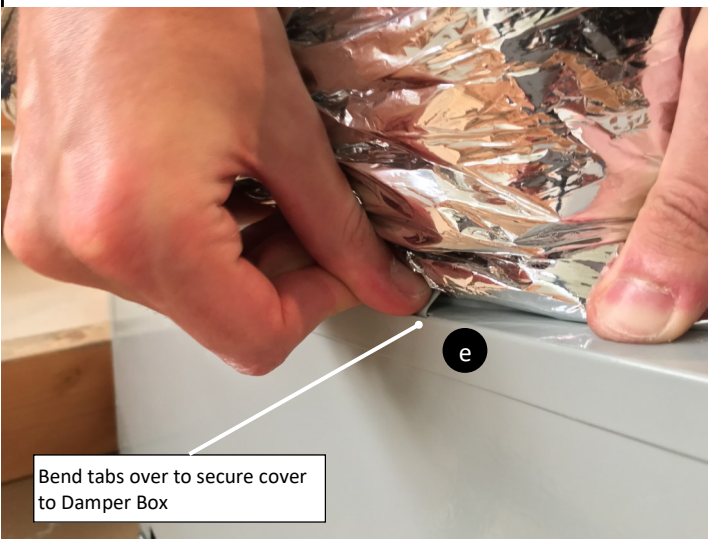
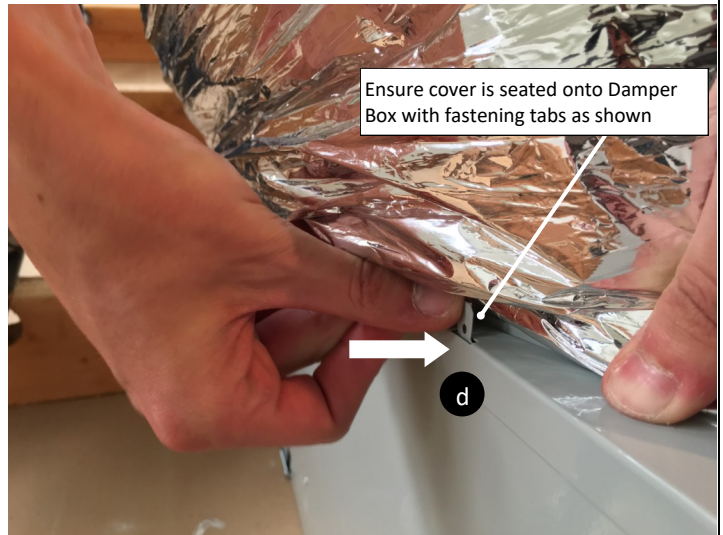
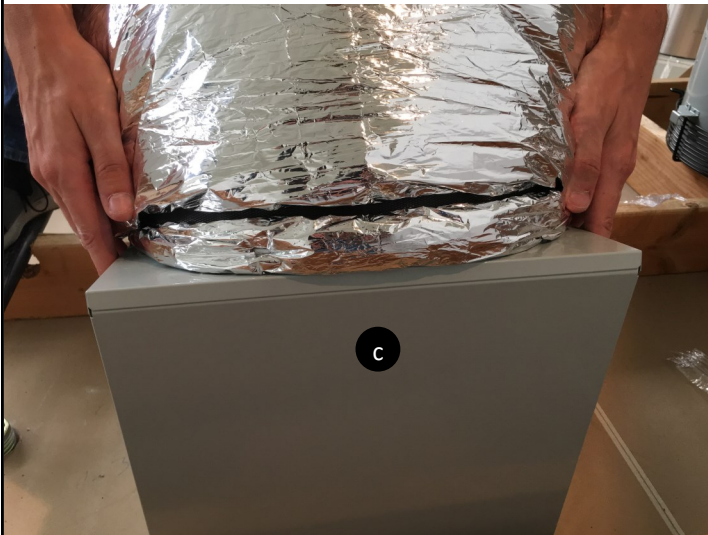
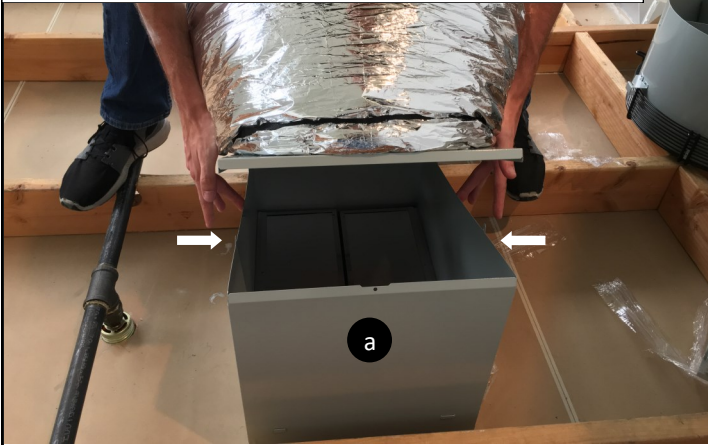

For the most current Installation Instructions, please visit [www.solatube.com/instructions](http://www.solatube.com/instructions)  
Solatube International, Inc. | 2210 Oak Ridge Way | Vista, CA 92081-8341 | [www.solatube.com](http://www.solatube.com) | T: 888.SOLATUBE

# 12

## Install HushMount Assembly

Determine the best location to install the HushMount Assembly on the attic floor.

NOTE: Choose a location that will ensure no restrictions in the ducting.

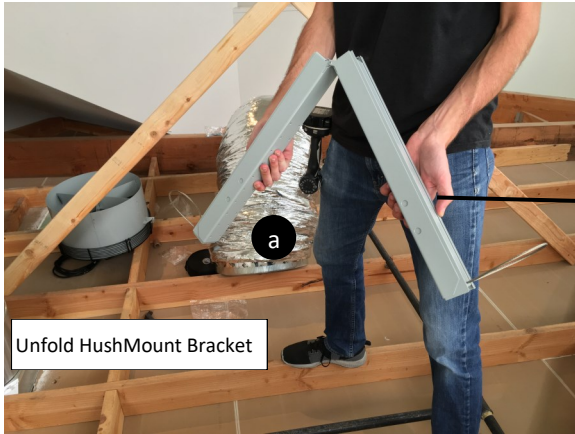

Unfold HushMount Bracket

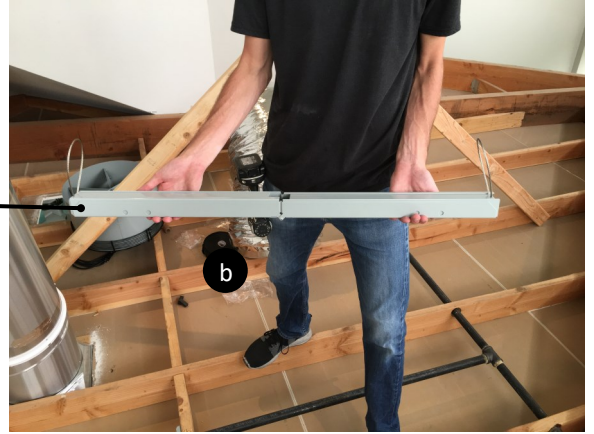

It is preferred to install the HushMount Bracket spanning two (2) ceiling joists for added support.

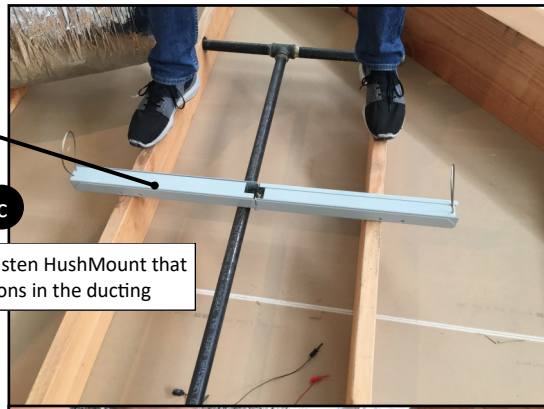
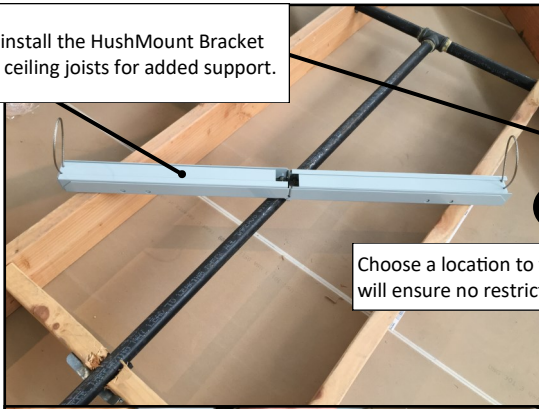

Choose a location to fasten HushMount that will ensure no restrictions in the ducting

Fasten HushMount to ceiling joist or plywood flooring with four (4) 1-1/2 in. hex head screws. Two (2) on each end of bracket

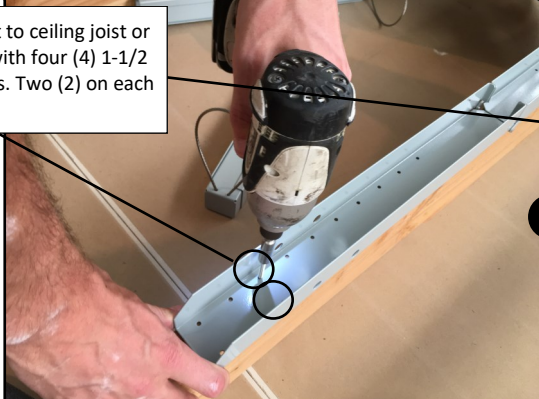

Insert HushMount Posts into bracket. Ensure brackets are snapped into place.

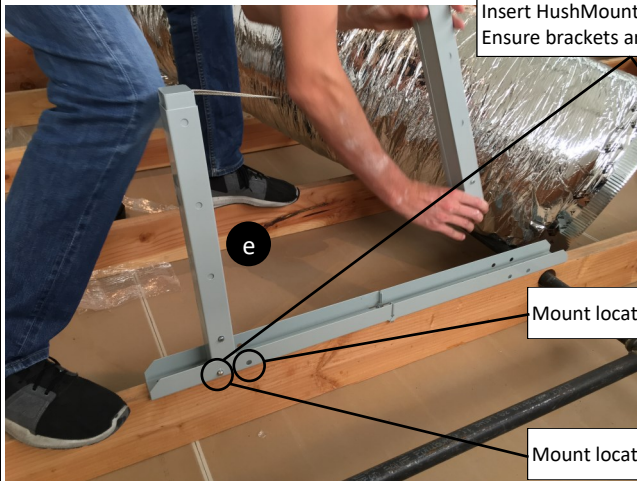

Mount location for 1500 Fan



Mount location for 3000 Fan

13

Adjust HushMount Post to Appropriate Height with Spring Clip

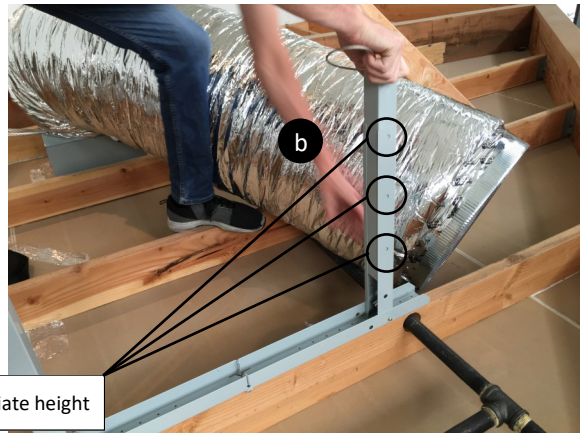

Adjust to appropriate height

14

Place Fan Assembly onto HushMount Hanging Wire

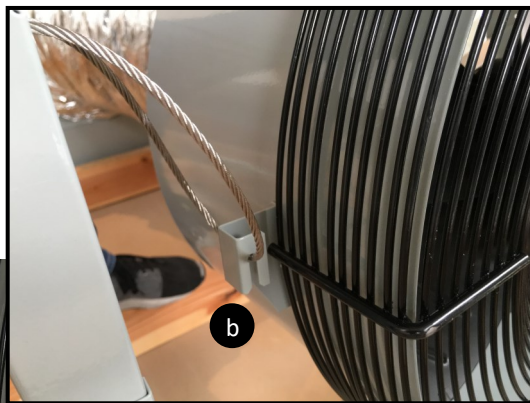
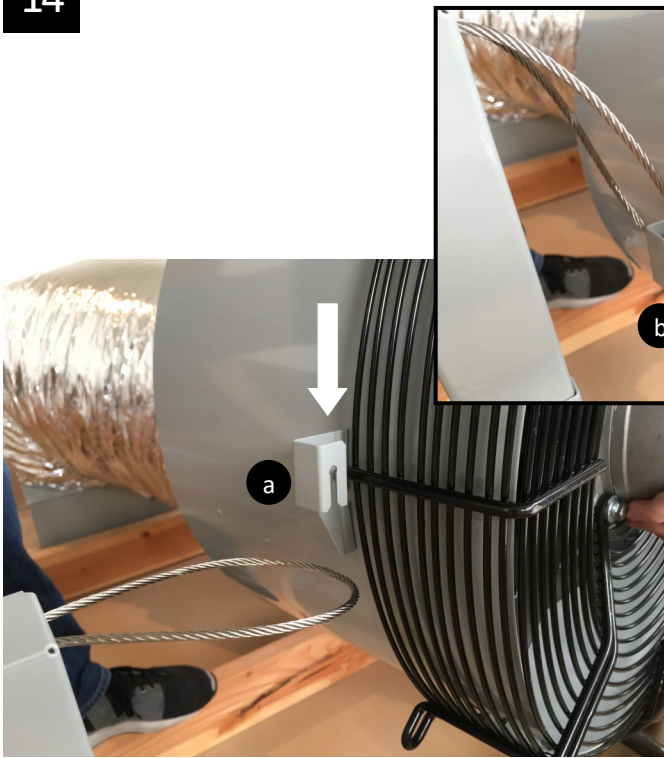

15

Fasten Ducting to Fan  
Slide ducting into fan assembly

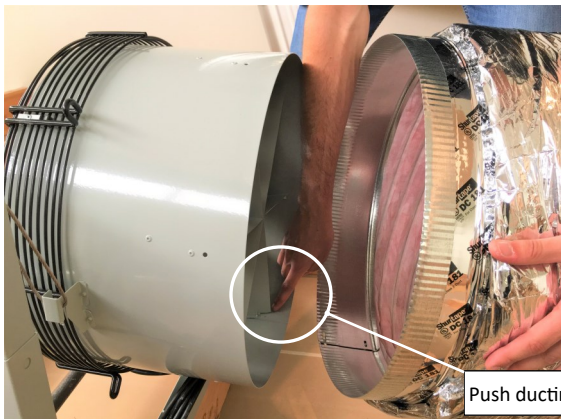

Push ducting into fan until it rests against stop.

16

**Fasten Ducting to Fan Assembly**

Secure ducting with three (3) 5/8 in. hex head drill tip screws evenly around the circumference of the fan collar.

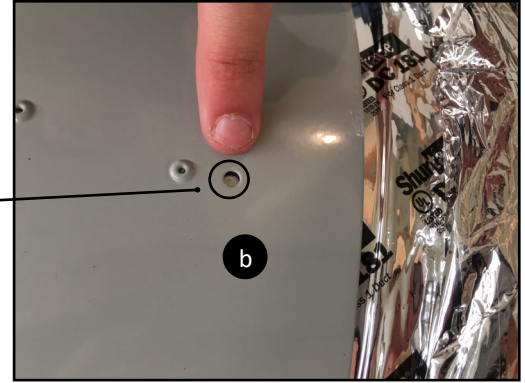

Ensure ducting is visible through pre-punched screw holes



Fasten with three (3) 5/8 in. hex head drill tip screws

17

**Install Strapping**

Use a custom length of strapping material to install a center strap on the ducting to keep the ducting in an optimum curve and maximizing air flow. Fasten each side of strapping with 1-1/2 in. Hex Head Drill Tip Screws and Washers.



12

For the most current Installation Instructions, please visit [www.solatube.com/instructions](http://www.solatube.com/instructions)

Solatube International, Inc. | 2210 Oak Ridge Way | Vista, CA 92081-8341 | [www.solatube.com](http://www.solatube.com) | T: 888.SOLATUBE

18

Plug Fan Cord into Outlet

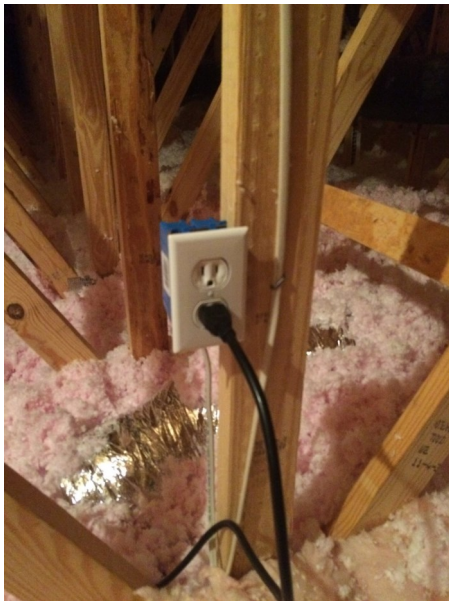

19

Remove Battery Tab from Remote

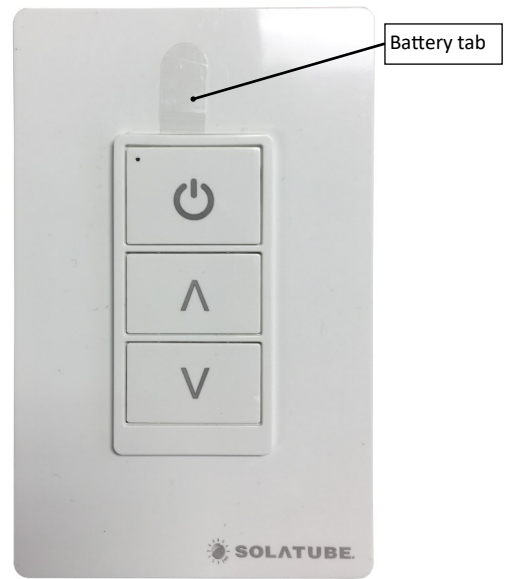

20

The fan will be placed into pairing mode when plug is inserted into outlet. Once fan is plugged into outlet, press and hold Power button on remote until fan control beeps. Remote is now paired with fan. Test remote by pressing Power button. Please Note: Fan will always start in highest speed.

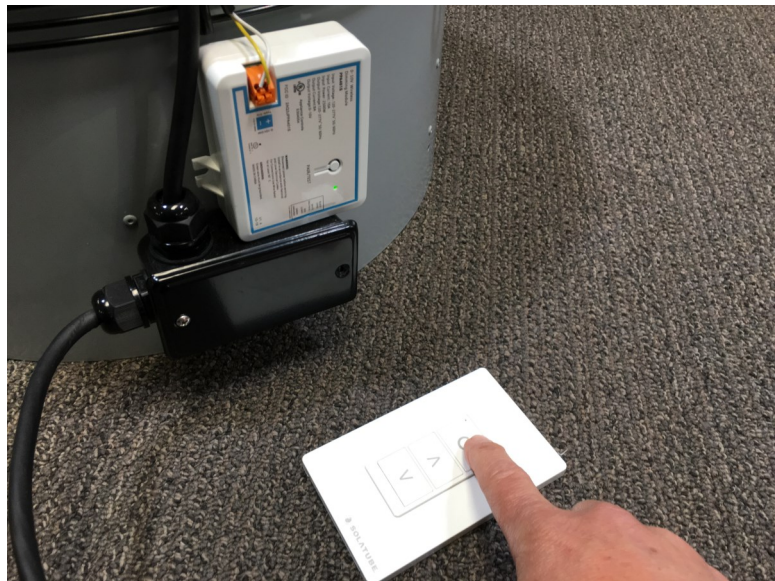
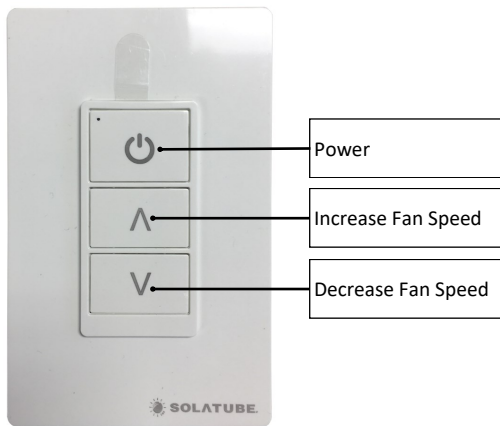

21

Pairing A New Remote

1. Press and release Pair/Test button on fan motor until green light flashes.
2. Press and hold Power button on remote until fan control beeps.
3. Remote is now paired with fan.

Remove A Remote From Pairing

1. Press and hold Pair/Test button on fan motor until motor beeps rapidly 4 times.
2. Remote is now removed from motor memory.

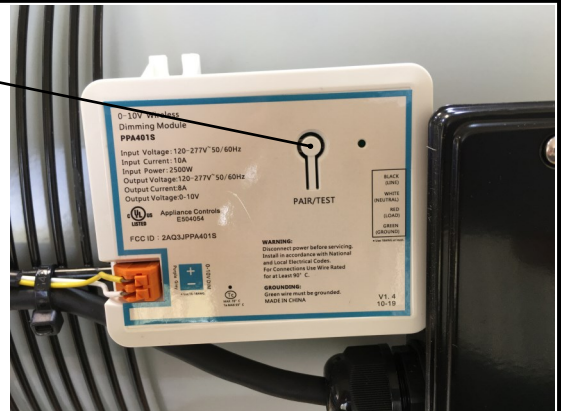

# 22

## Install Remote to Wall (Optional)

The remote control can be left on a counter or table, or can be fastened to a wall.



Remove remote from packaging

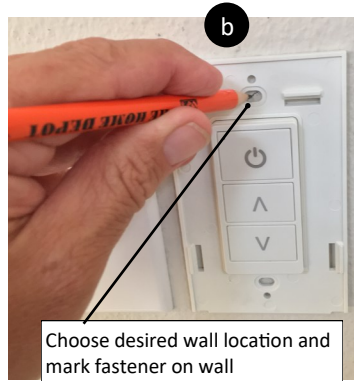

Drill marked fastener locations

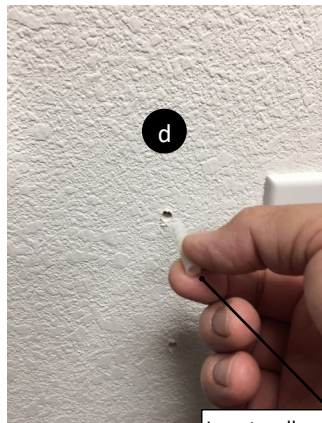

Insert wall anchors into drilled holes

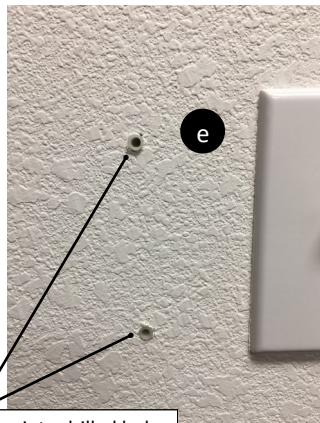

Place wall plate over wall anchors and fasten to wall



Place cover over wall plate



Press cover onto wall plate until it snaps into place



The remote can be pulled out of the wall plate if desired



# 23

## Replace Remote Battery

Use 2032 coin cell battery

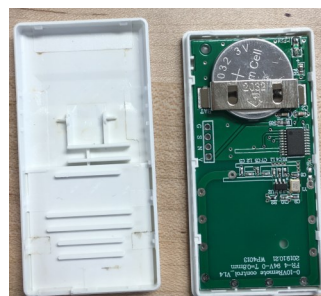

Remove back cover from remote to replace battery



# 1

## Garage Fan Instructions

Note: The following instructions should only be performed by a licensed electrician.  
Please follow all local municipal and building code requirements prior to making electrical connections.

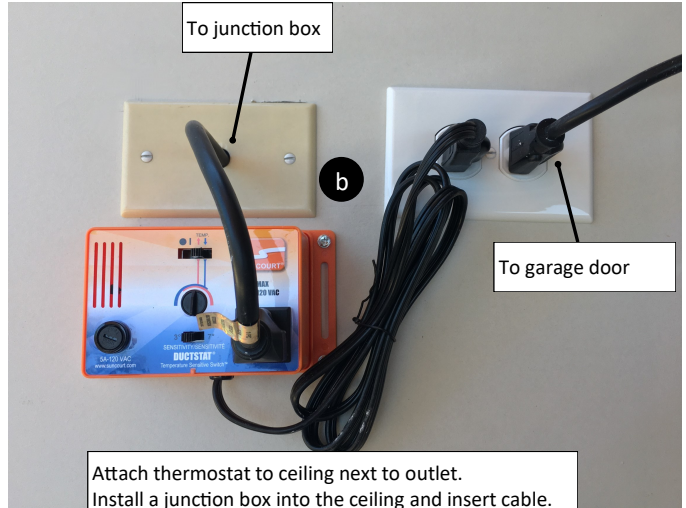

# 2

Install junction box in attic just above outlet. Connect cable from thermostat to garage fan.  
Secure cable trough junction box and secure to framing member.  
The Garage Fan models GF1500T and GF3000T come with the outlet cord detached.



Insert garage fan outlet cord through junction box



Continue to feed cord through junction box

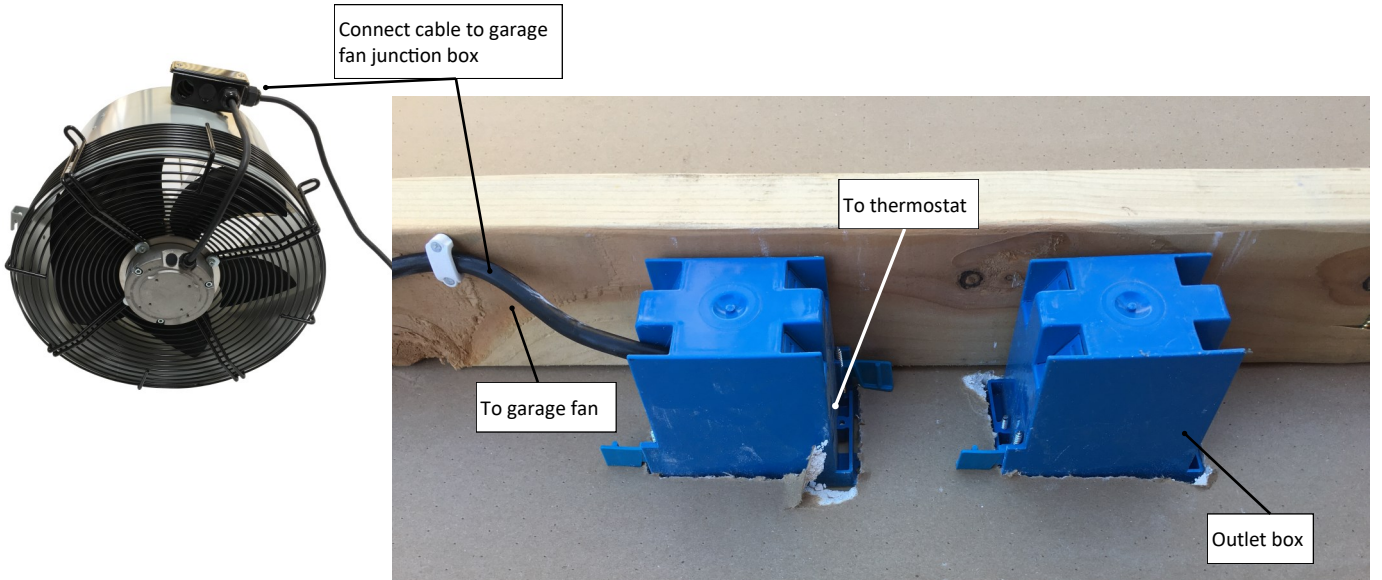

# 2

## Garage Fan Instructions

The Garage Fan models GF1500T and GF3000T come with the outlet cord detached.

**WARNING:** To avoid risk of shock, make wire connections prior to plugging into outlet.

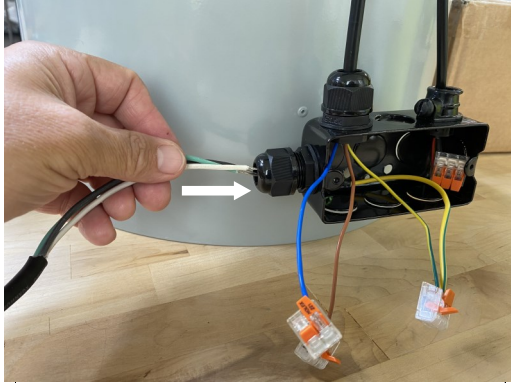

Insert outlet cord into junction box through provided strain relief

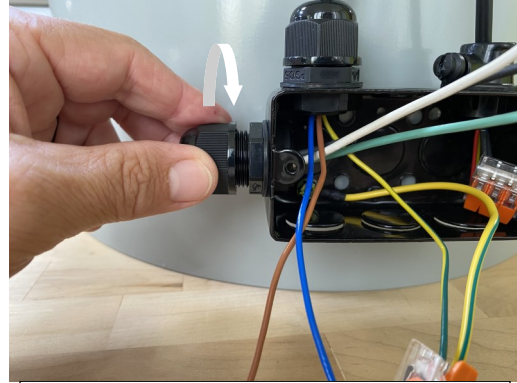

Secure outlet cord to junction box by tightening strain relief

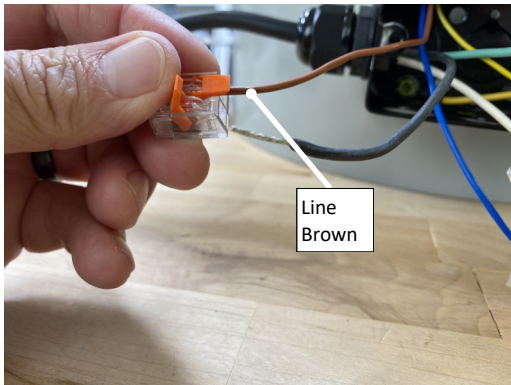

Line  
Brown

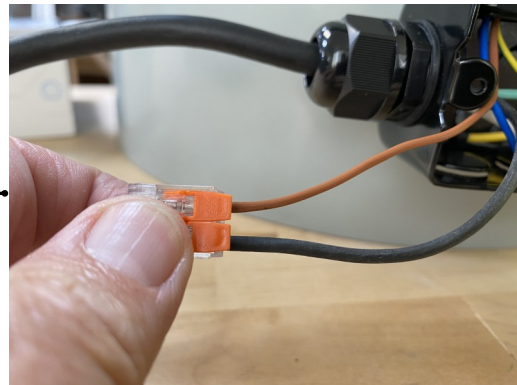

Push black (Line) wire into quick connect terminal block and fasten. Ensure proper connection by firmly pulling on black wire.

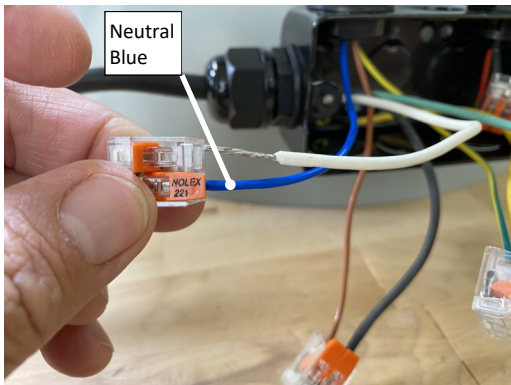

Neutral  
Blue

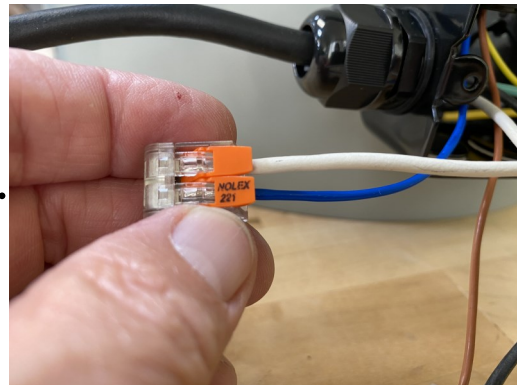

Push white (Neutral) wire into quick connect terminal block and fasten. Ensure proper connection by firmly pulling on white wire.

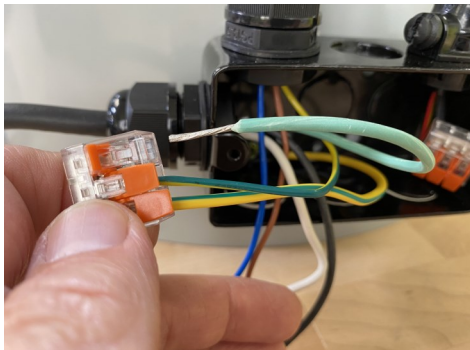

Push green (Ground) wire into quick connect terminal block and fasten. Ensure proper connection by firmly pulling on green wire.

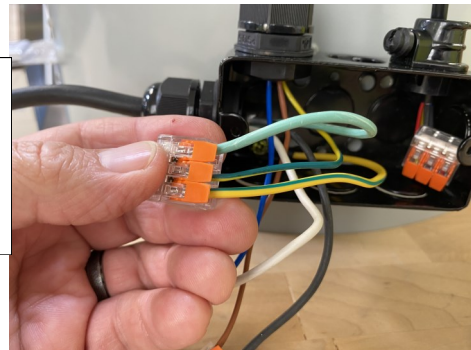



### 3

#### Garage Fan Instructions

Note: The following instructions should only be performed by a licensed electrician.

Please follow all local municipal and building code requirements prior to making electrical connections.

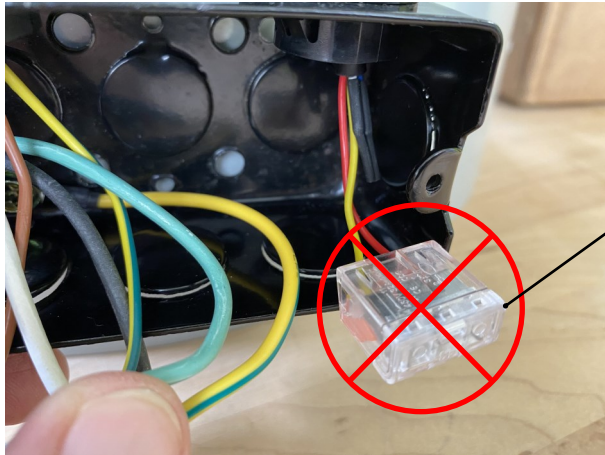

These wires are left alone. Do not make any wire connections to this terminal.



Plug outlet cord into thermostat once wire connections are completed.

### 4

#### Adjust Thermostat

Slide thermostat switch to heat mode.

Set switch to 3°

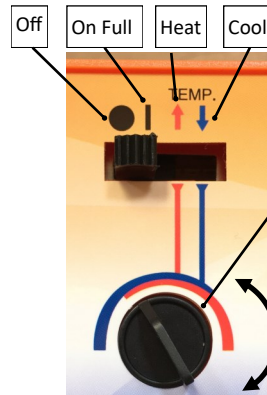

Adjust dial to desired setting.

Turn dial clockwise until it reaches stop. Fan will turn on. Then turn dial counterclockwise just until fan turns off. This may need to be adjusted several times at initial set up when temperature changes.

Once set, the garage fan will automatically turn on when temperature reaches thermostat setting.



Solatube International, Inc.,  
2210 Oak Ridge Way, Vista CA 92081-8341  
Phone (800) 966-7652 • Fax (760) 599-5181  
[www.solatube.com](http://www.solatube.com) Part No. 941572 v1.3